



V2000SX

Standard Thermostatic Valve

Presetable thermostatic valve body with standard flow range

APPLICATION

The V2000SX is a range of thermostatic radiator valves with a wide range of flow rate pre-settings for balancing of heating systems, which makes the V2000SX an almost universal valve for pumped two-pipe heating and cooling systems. The V2000SX valves have a quiet operation in both standard and reverse flow direction. It is recommended to fit them at the supply of a radiator, but fitting the valves at the return of the radiator is also possible.

The V2000SX range covers a wide range of dimensions, patterns and connections, offering a solution for almost all installation situations in new building, renovation and retrofit projects.

APPROVALS

- Keymark certified and tested to EN 215

SPECIAL FEATURES

- Wide range of flow rates easily adjustable by a setting key (see 'Accessories')
- Augmented nominal flows with high-stroke thermostatic heads T3019HF and T6001HF
- Maximum flow limited to max. 130 % of nominal flow to prevent misbalance during heating of cooled down rooms
- Quiet operation, including in reversed flow direction
- Strong restoring spring, which is not immersed in water, ensuring durability of the valve
- Double o-ring seal for maintenance-free operation
- Standard dimensions per EN215, complemented with an extended range of patterns and connection threads
- Standard M30 x 1.5 thermostat connection
- Valves can be shut-off with the protection cap
- V2000SX valves are compatible with the following Honeywell Home actuators:
 - All radiator thermostats with M30 x 1.5 connection
 - HR types of Evohome and Roomtronic actuators
 - MT4 actuators
 - M4410E/K and M7410E5001 modulating actuators
- The valve insert can be replaced while the system is operating and without draining using the service tool (see 'Accessories')
- Valve housing and insert fits to Honeywell Home AT-Concept design, ensuring housing and insert cross compatibility with MNG, Honeywell and Honeywell Home thermostatic valves produced by Resideo and its predecessors since 1974



TECHNICAL DATA

Media	
Medium:	Water or water-glycol mixture, quality to VDI 2035
pH-value:	8 - 9,5
Connections/Sizes	
Body-head connection:	M30 x 1.5
Sizes:	DN10, DN15, DN20
Operating temperatures	
Max. operating temperature:	130 °C
Min. operating temperature medium:	-10 °C non-freezing
Pressure values	
Max. operating pressure:	PN10, 10 bar (1000kPa)
Max. differential pressure:	1.0 bar (100 kPa)
Differential pressure recommended for quiet operation:	≤0.2 bar (20 kPa)
Flow rates	
Nominal flow range:	20 - 170 l/h
Max. nominal flow at 10 kPa (EN 215) – standard head:	170 l/h ± 10 %
Max. nominal flow at 10 kPa (EN 215) – high-stroke head:	210 l/h ± 10 %
Specifications	
Closing dimension:	11.5 mm
Factory setting:	position 6
Identification	
- Ivory colour protection cap with embossed 'SX' on the top	
- Ivory colour plastic dial on the top of valve insert	

CONSTRUCTION

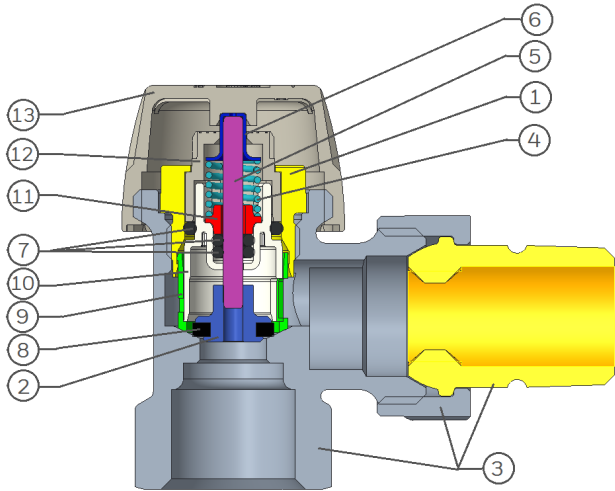
Overview	Components	Materials
	1 Insert cartridge	
	2 Plunger	Brass
	3 Valve body, tailpiece, nut	
	4 Return spring	
	5 Spindle	Stainless steel
	6 Spindle cap	
	7 O-rings	EPDM 70
	8 Plunger seal	
	9 Orifice casing	PPS GF40
	10 Setting screen	
	11 Retaining bushing	PBT GF30
	12 Setting dial	
	13 Protection cap	PP GF10

METHOD OF OPERATION

The V2000SX valve is controlled by the radiator thermostat. Air from the room passing over the sensor of the radiator thermostat causes the sensor to expand when the temperature rises. The sensor pushes the valve spindle, closing the valve.

When the temperature falls, the sensor contracts and the spring-loaded valve spindle is opened. The TRV opens in proportion to the temperature of the sensor. Only the amount of water required to maintain the room temperature set on the radiator thermostat can flow into the radiator.

The V2000SX valves have the plunger surrounded by a casing with different orifices and a mating setting screen with one orifice. When the setting dial on top of the valve cartridge is rotated, an orifice in the setting screen aligns with the respective orifice in the casing. Thus, the orifice limiting the maximum flow through the valve is selected.

The stroke/flow characteristic and the size of the orifices is designed to provide for a proportional increase of flow with the stroke, while limiting the maximum flow to not more than 130 % of the nominal flow of the valve. This prevents an oversupply of the controlled radiator and a loss of the system balancing in cases when the radiator setting has been turned high in a cooled down room.

The V2000SX valves are suitable for system design with 1K to 2K p-band control range. In combination with the T3019HF and T6001HF thermostatic heads with high specific stroke, the V2000SX valves are suitable for system design with 0.5K to 2K p-band control range.

TRANSPORTATION AND STORAGE

Keep parts in their original packaging and unpack them shortly before use.

The following parameters apply during transportation and storage:

Parameter	Value
Environment:	clean, dry and dust free
Min. ambient temperature:	0 °C
Max. ambient temperature:	50 °C
Max. ambient relative humidity:	75 % *

*non condensing

INSTALLATION GUIDELINES

- The V2000SX valves are primarily designed for use in pumped 2-pipe heating systems with thermostatic flow control
- It is recommended to install the V2000SX valves on the supply side of a heat exchanger, so that the heating medium flows in the direction indicated by the arrow on the body. However, the V2000SX valves are designed and tested also for a trouble-free operation in the reverse flow direction and installation at the return is hence also possible. This also allows to flip an external threaded angled valve and install it as an axial valve
- Similarly, a double angle valve with external thread can also be flipped from right to left and vice-versa
- It is also recommended to install the V2400 series "Verafix" return valves at the other end of the heat exchanger. The Verafix allows for shut-off and drain-down of the radiator. But it can also be throttled to dissipate excessive differential pressure across a radiator and hence reduce any noise that could otherwise occur
- It is recommended to effectuate valve presetting to achieve hydraulic balancing and improve comfort and energy efficiency, even in smaller systems. Static balancing has been shown to result in up to 5 % of energy savings
- In larger systems with static balancing, it is recommended to install V5032 pipeline balancing valves at the return of each branch or riser
- In large systems, hydraulic balancing with the V2000SX series valves works best in combination with the V5010 Kombi-3 or V5001P Kombi-Auto differential pressure control valves installed on each heating branch or riser. Dynamic balancing compensates for varying temperature setting and heat load conditions, and has been shown to result in up to 10 % of energy savings
- The V2000SX valve bodies can be used with all Honeywell Home thermostatic heads with M30x1.5 connection and with recommended Honeywell Home thermoelectric or motorized actuators (see section Recommended Actuators below). When using actuators from other manufacturers, make sure to select actuators with pressure force not exceeding 100N
- When the design nominal flow exceeds 170l/h, the T3019HF and T6001HF thermostatic heads with high specific stroke, or the HR series electronic heads should be used with the V2000SX valves in order to provide the necessary flow capacity

Installation Example

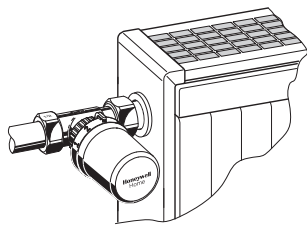

Fig. 1. Straight

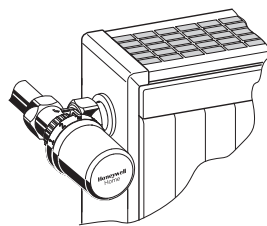

Fig. 2. Angled

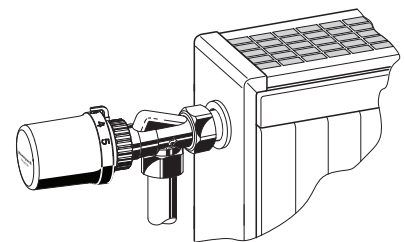

Fig. 3. Axial

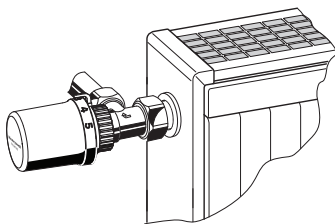

Fig. 4. Angled with external thread installed as axial

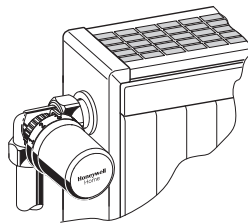

Fig. 5. Double angle (corner) left

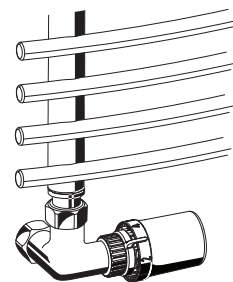

Fig. 6. Double angle (corner) left on a towel radiator

Setup requirements

- To avoid stone deposit and corrosion the composition of the medium should conform with VDI-Guideline 2035
- All additives and lubricants used for heating medium treatment have to be suitable for EPDM seals to avoid their disintegration. Use of mineral oils should be avoided
- For industrial and long-distance energy systems please refer to applicable codes VdTÜV and 1466/AGFW FW 510
- Heavy polluted existing heating systems must be flushed thoroughly before replacing thermostatic valves
- The heating system must be fully deaerated
- Any complaints or costs resulting from non-compliance with above rules will not be accepted Resideo and its subsidiaries manufacturing the Honeywell Home products

Recommended actuators

- V2000SX flow characteristics are designed for control by thermostatic heads, which provide for proportional regulation within the 2K p-band stroke (0.45 mm). The valves are therefore best controlled by a mechanical or electronic thermostatic head
- All Honeywell Home thermostatic radiator heads with M30x1.5 connection fit the V2000SX valves
- Honeywell Home HR90, HR91 and HR92 electronic TRV heads are suitable for the V2000SX valves
- Honeywell Home MT4 thermoelectric actuators can be used for on/off control of the V2000SX valves
- Thermostatic radiator valves are intentionally designed such that they reach the design flow capacity at 2K p-band stroke (0.45 mm) and the max. flow rate exceeds the nominal flow rate by not more than 30 %. Thus, the modulating actuators used need to be able to provide for precise proportional flow control over a very small stroke range, because at higher strokes, the flow is limited by the presetting
- The M4410E/K and M7410E5001 modulating actuators are recommended

TECHNICAL CHARACTERISTICS

Presetting

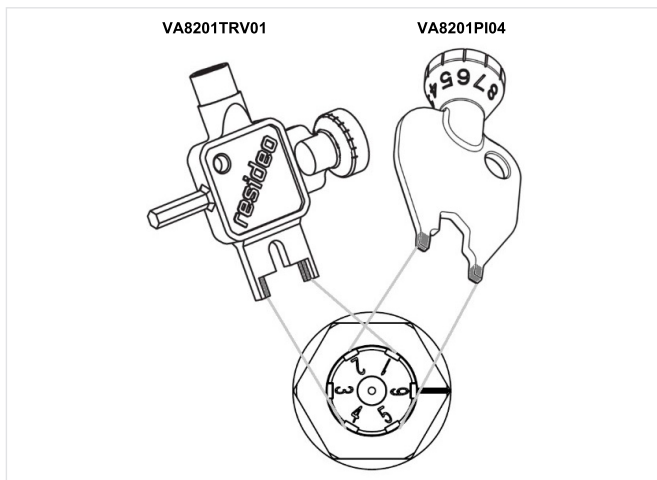

- The flow rates can be adjusted to one of the 6 settings (20 to 170 l/h for standard heads and 20 to 210 l/h for heads with high specific stroke)
- If the required maximum flow does not match exactly the setting value, use the closest higher setting
- The setting is changed using a special setting key
 - Slide the forked part of the setting key into two opposite grooves in the setting dial of the valve
 - Turn the setting key until the desired setting value is against the reference mark on the brass cartridge of the insert
 - The setting dial can be rotated in any direction
 - Do not use intermediate settings
- The default factory setting is position 6

Flow tolerances

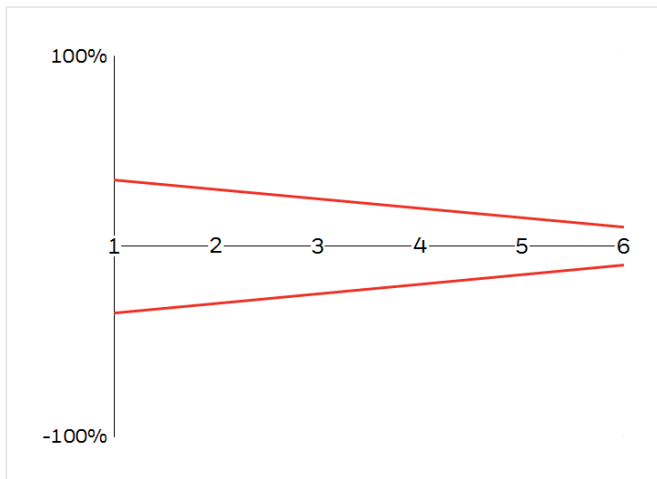

Design example

- Heat load: $Q=1000\text{ W}$
- Supply vs. return temperature difference: $\Delta T=15\text{ K}$
- Calculated mass flow: $\dot{m} = Q / (c \times \Delta T) = 1000 / (1.163 \times 15) = 57\text{ l/h}$
- Control within: 2K p-band
- Available differential pressure: $\Delta p = 100\text{ mbar (10 kPa)}$
- Valve setting from charts on following pages (use next higher setting): 4

Flow Rate

All angled valves, DN15/DN20 straight and DN15 axial valves, with standard heads (0.22mm/K stroke)

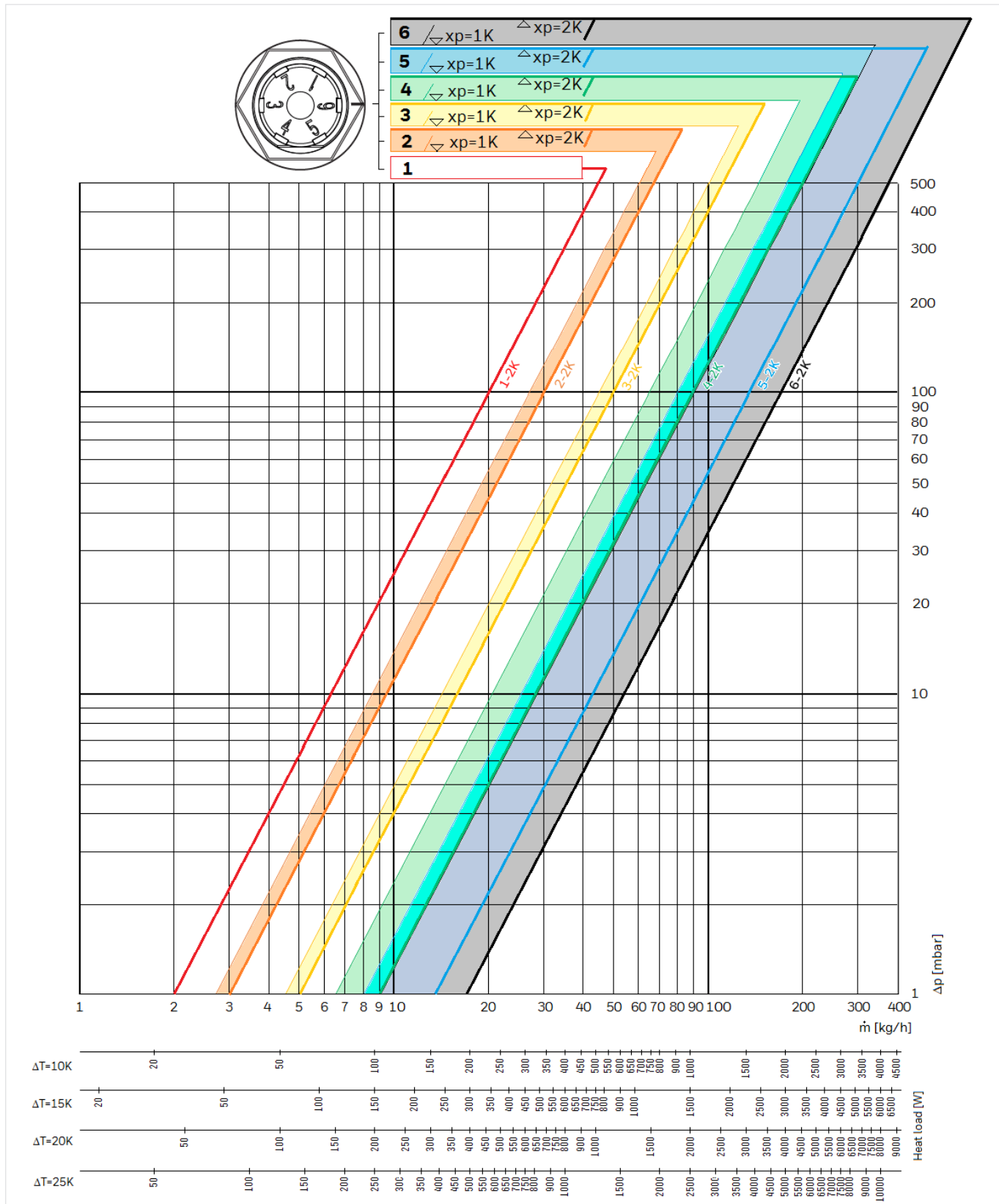

Presetting	1	2	3	4	5	6
kv-value, 1K p-band	0.063	0.085	0.14	0.21	0.25	0.28
kv-value, 2K p-band	0.063	0.095	0.16	0.28	0.43	0.54
kvs	0.063	0.104	0.18	0.34	0.52	0.70

DN10 Axial, double angle (corner) valves and DN10 straight valves, with standard heads (0.22 mm/K stroke)

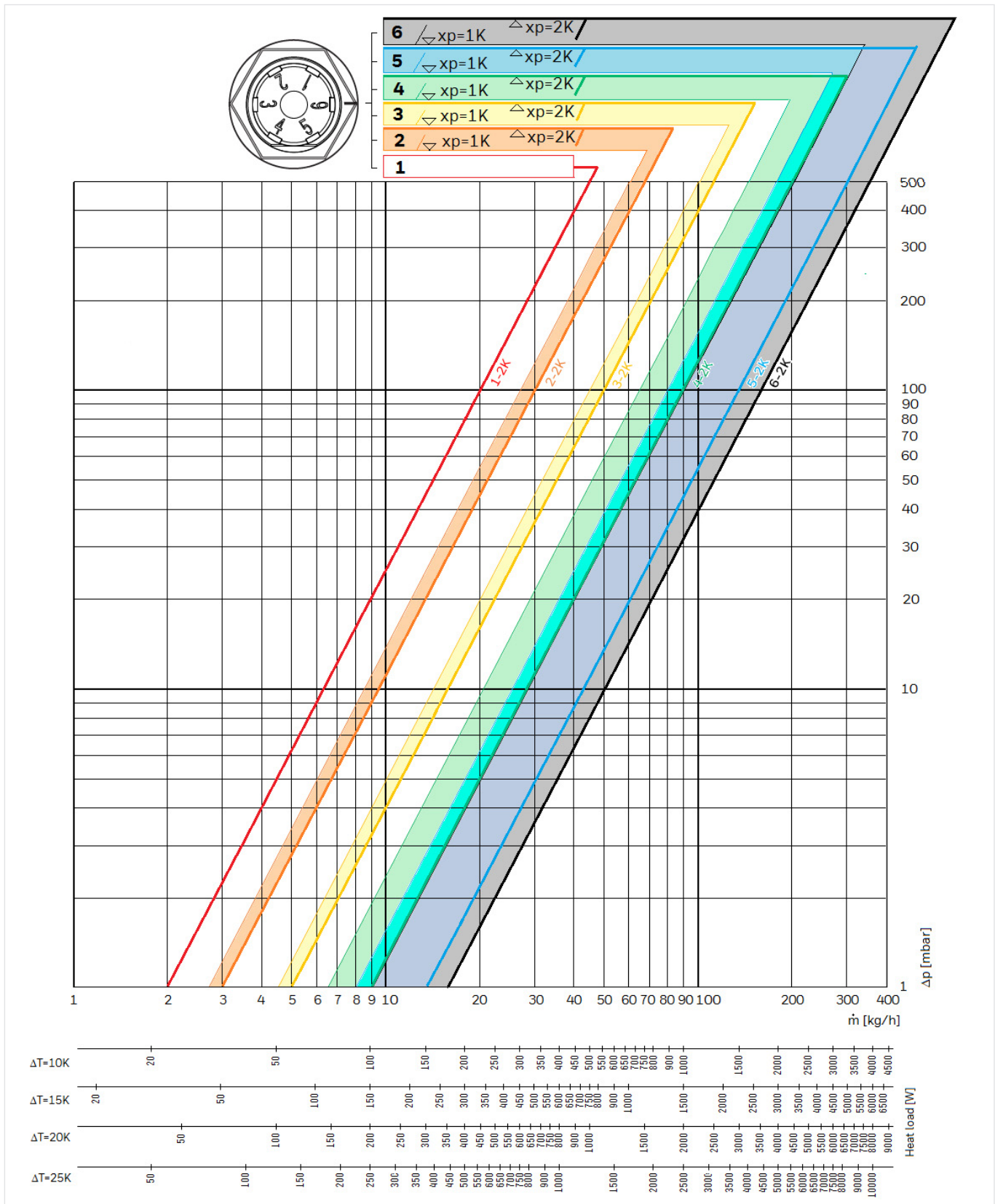

Presetting	1	2	3	4	5	6
kv-value, 1K p-band	0.063	0.085	0.14	0.21	0.25	0.28
kv-value, 2K p-band	0.063	0.095	0.16	0.28	0.43	0.51
kvs	0.063	0.104	0.18	0.34	0.52	0.62

All angled valves, DN15/DN20 straight and DN15 axial valves, with T3019HF or T6001HF head (0.35 mm/K stroke)

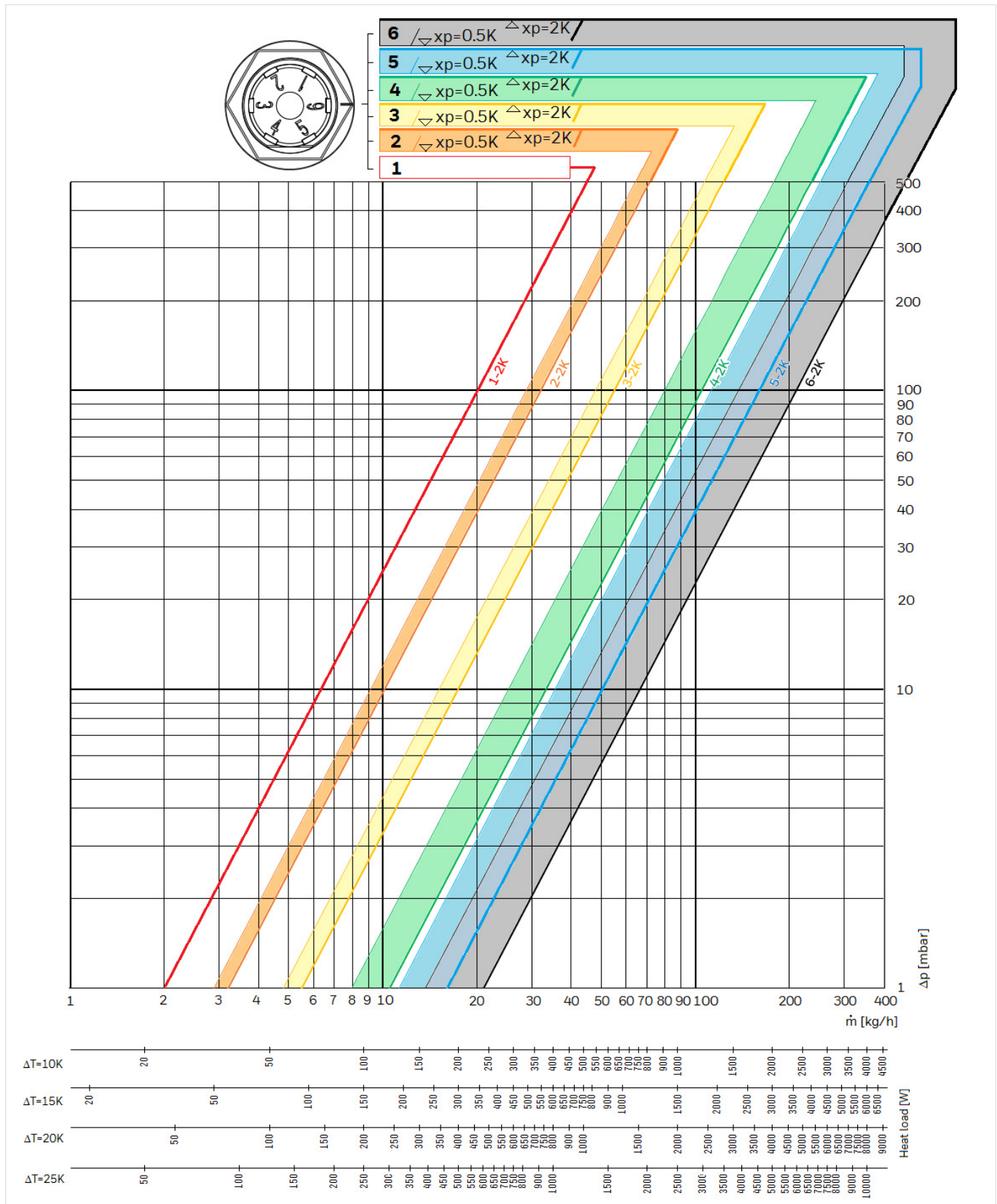

DN10 axial, double angle (corner) valves and DN10 straight valves, with T3019HF or T6001HF head (0.35 mm/K stroke)

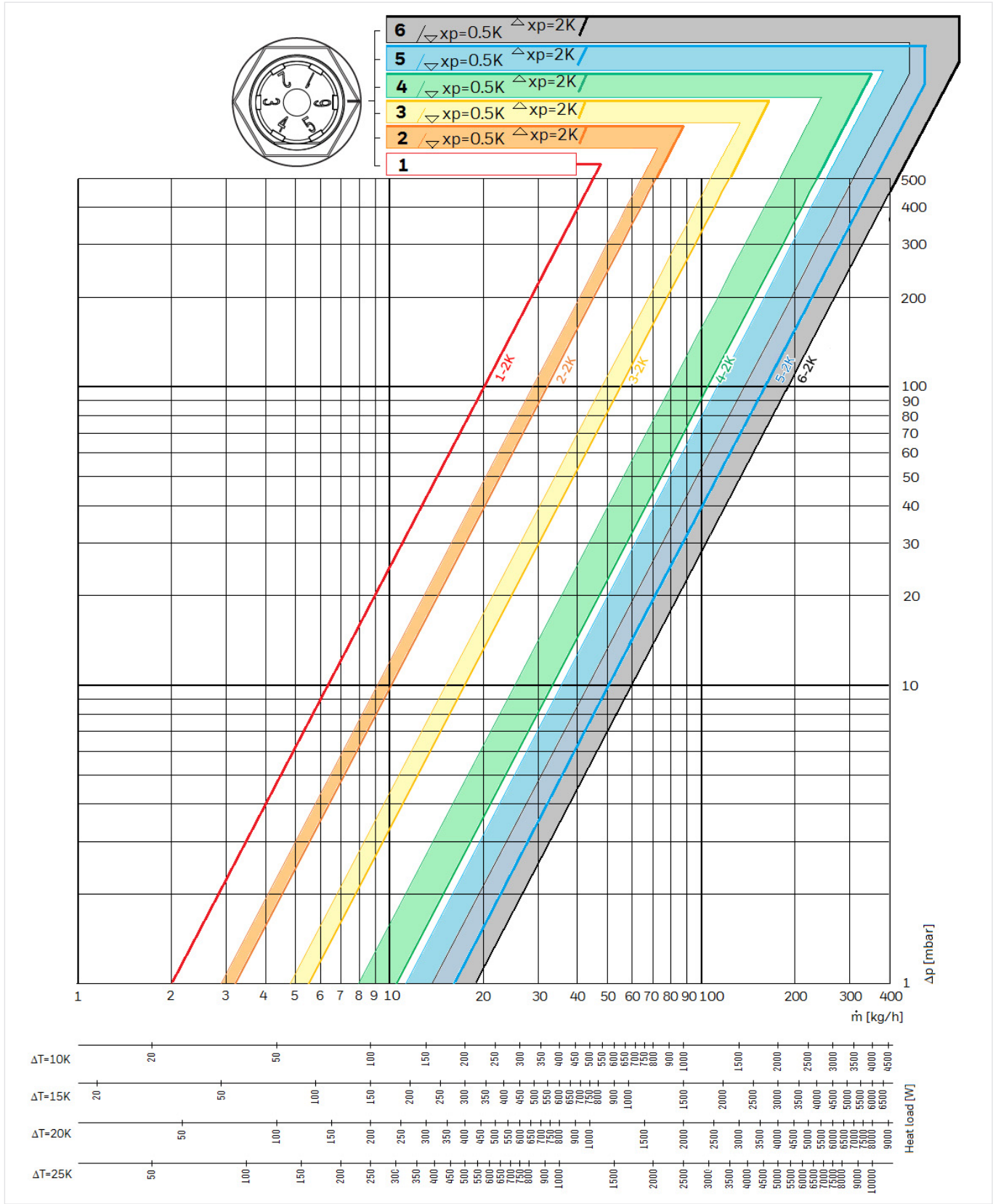

Presetting	1	2	3	4	5	6
kv-value, 0.5K p-band	0.063	0.091	0.15	0.25	0.36	0.43
kv-value, 1K p-band	0.063	0.095	0.16	0.27	0.40	0.46
kv-value, 2K p-band	0.063	0.101	0.17	0.33	0.51	0.60
kvs	0.063	0.104	0.18	0.34	0.52	0.62

DIMENSIONS AND ORDERING INFORMATION

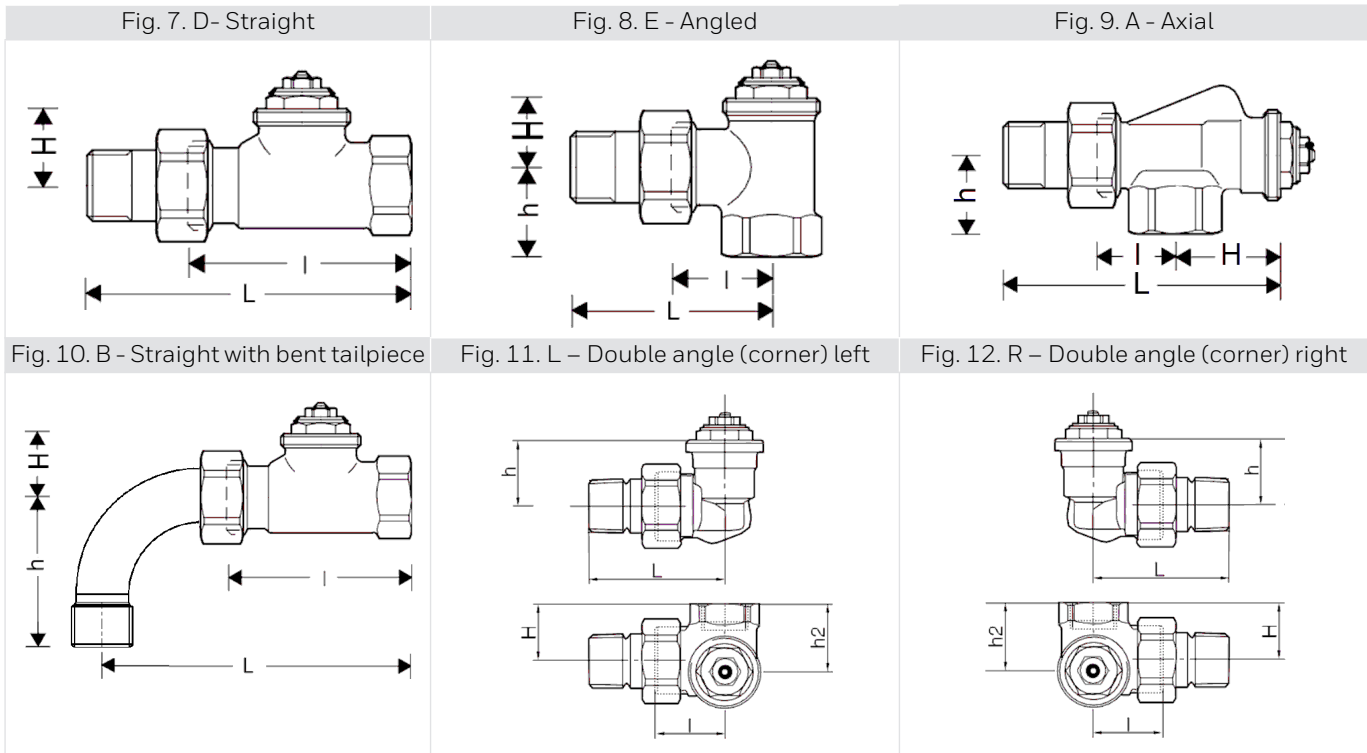

Note: All dimensions in mm unless stated otherwise.

Ranges

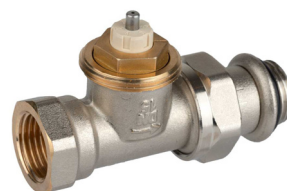
V2000/V2020	V2026	V2030	V2036
Bodies with internal threads and metal-to-metal sealing radiator tailpieces	Bodies with external threads and metal-to-metal sealing radiator tailpieces	Bodies with internal threads and soft sealing radiator tailpieces	Bodies with external threads and soft sealing radiator tailpieces
			

V2000/V2020: Bodies with internal threads and metal-to-metal sealing radiator tailpieces

Body type	DN	EN 215 certified	Q _{nom} range with std. head	Pipe connection	l	L	h	H	h ₂	OS-No.
E - Angled per EN 215 D -Series	10	•	20-170kg/h	Rp 3/8"	26	52	22	20	-	V2000ESX10
	15	•	20-170kg/h	Rp 1/2"	29	58	26	20	-	V2000ESX15
	20	•	20-170kg/h	Rp 3/4"	34	66	29	19	-	V2000ESX20
D - Straight per EN215 D -Series	10	•	20-160kg/h	Rp 3/8"	59	85	-	25	-	V2000DSX10
	15	•	20-170kg/h	Rp 1/2"	66	95	-	25	-	V2000DSX15
	20	•	20-170kg/h	Rp 3/4"	74	106	-	25	-	V2000DSX20
B - Straight with bent tailpiece	15	•	20-170kg/h	Rp 1/2"	66	108	52	25	-	V2000BSX15
E - Angled per EN 215 F -Series	10	•	20-170kg/h	Rp 3/8"	24	49	20	21	-	V2020ESX10
	15	•	20-170kg/h	Rp 1/2"	26	53	23	22	-	V2020ESX15
	20	•	20-170kg/h	Rp 3/4"	34	66	29	18	-	V2020ESX20
D - Straight per EN 215 F -Series	10	•	20-160kg/h	Rp 3/8"	50	75	-	26	-	V2020DSX10
	15	•	20-170kg/h	Rp 1/2"	55	82	-	26	-	V2020DSX15
	20	•	20-170kg/h	Rp 3/4"	74	106	-	24	-	V2020DSX20
A - Axial	10	•	20-160kg/h	Rp 3/8"	24	50	22	33	-	V2000ASX10
	15	•	20-160kg/h	Rp 1/2"	26	54	26	35	-	V2000ASX15

Body type	DN	EN 215 certified	Q _{nom} range with std. head	Pipe connection	l	L	h	H	h ₂	OS-No.
L – Double Angle (Corner) Left	10		20-160kg/h	Rp 3/8"	24	53	26	22	26.5	V2020LSX10
	15		20-160kg/h	Rp 1/2"	24	53	26	26	30.5	V2020LSX15
R – Double Angle (Corner) Right	10		20-160kg/h	Rp 3/8"	24	53	26	26	26.5	V2020RSX10
	15		20-160kg/h	Rp 1/2"	24	53	26	26	30.5	V2020RSX15

V2026: Bodies with external threads and metal-to-metal sealing radiator tailpieces

Body type	DN	EN 215 certified	Q _{nom} range with std. head	Fitting connection thread	l	L	h	H	h ₂	OS-No.
E – Angled (A – Axial when flipped)	15		20-170kg/h	G 3/4"	26	53	23	22	-	V2026ESX15
D – Straight	10		20-160kg/h	G 3/4"	50	75	-	26	-	V2026DSX10
	15		20-160kg/h	G 3/4"	55	82	-	26	-	V2026DSX15
B – Straight with bent tailpiece	15		20-170kg/h	G 3/4"	55	97	52	26	-	V2026BSX15





V2030: Bodies with internal threads and soft sealing radiator tailpieces

Body type	DN	EN 215 certified	Q _{nom} range with std. head	Pipe connection	l	L	h	H	h ₂	OS-No.
E – Angled per EN 215 F -Series	10	•	20-170kg/h	Rp 3/8"	24	49	20	21	-	V2030ESX10
	15	•	20-170kg/h	Rp 1/2"	26	53	23	22	-	V2030ESX15
D – Straight per EN215 F -Series	10	•	20-160kg/h	Rp 3/8"	50	75	-	26	-	V2030DSX10
	15	•	20-170kg/h	Rp 1/2"	55	82	-	26	-	V2030DSX15
A – Axial	10		20-160kg/h	Rp 3/8"	24	50	22	33	-	V2030ASX10
	15		20-160kg/h	Rp 1/2"	26	54	26	35	-	V2030ASX15
L – Double Angle (Corner) Left	15		20-160kg/h	Rp 1/2"	24	53	26	26	30.5	V2030LSX15
R – Double Angle (Corner) Right	15		20-160kg/h	Rp 1/2"	24	53	26	26	30.5	V2030RSX15

V2036: Bodies with external threads and soft sealing radiator tailpieces

Body type	DN	EN 215 certified	Q _{nom} range with std. head	Fitting connection thread	l	L	h	H	h ₂	OS-No.
E – Angled	10		20-170kg/h	G 3/4"	24	49	20	21	-	V2036ESX10
E – Angled (A – Axial when flipped)	15		20-170kg/h	G 3/4"	26	53	23	22	-	V2036ESX15
D – Straight	15		20-170kg/h	G 3/4"	55	82	-	26	-	V2036DSX15
L – Corner Left	15		20-160kg/h	G 3/4"	24	53	26	26	30.5	V2036LSX15
R – Corner Right	15		20-160kg/h	G 3/4"	24	53	26	26	30.5	V2036RSX15

ACCESSORIES

	Description	Dimension	Part No.
	VA8201 Metallic presetting key with chrome plating		
	for PI, SX, FX and LX type valves		VA8201PI04
	VA8201 Plastic presetting key		
	for PI, SX, FX and LX type valves and Verafix lockshields		VA8201TRV01
	VA8200A Service tool to replace valve insert		
	for all V2000 types: SX, FX, LX, BB, UB and for legacy types: Kx, SL, SLGB, Mira		VA8200A001
	VA2202A Pressure cap – for shutting off valves on radiator outlet		
	G 5/8" internal thread - for DN10 valves		VA2202A010
	G 3/4" internal thread - for DN15 valves		VA2202A015
	G 1" internal thread - for DN20 valves		VA2202A020

	VA5090	Sealing ring for pressure cap		
		for VA2202A010	VA5090A010	
		for VA2202A015	VA5090A015	
		for VA2202A020	VA5090A020	
	VA5201A	Radiator tailpiece with thread up to collar		
		3/8", DN10	VA5201A010	
		1/2", DN15	VA5201A015	
		3/4", DN20	VA5201A020	
	VA5204B	Extended radiator tailpiece, nickel-plated, to be shortened as required		
		3/8" x 70 mm (for DN10) thread approx. 50 mm	VA5204B010	
		1/2" x 76 mm (for DN15) thread approx. 65 mm	VA5204B015	
		3/4" x 70 mm (for DN20) thread approx. 60 mm	VA5204B020	
	VA6290	Reduction piece		
		1" pipe > 1/2" valve	VA6290A260	
		1 1/4" pipe > 1/2" valve	VA6290A280	
		1" pipe > 3/4" valve	VA6290A285	
		1 1/4" pipe > 3/4" valve	VA6290A305	
	FIG1/2CS	Compression fitting for COPPER and STEEL pipe		
		Consisting of compression nut and compression ring. For valves with internal thread.		
		3/8", DN10	10 mm	FIG3/8CS10
		3/8", DN10	12 mm	FIG3/8CS12
		1/2", DN15	10 mm	FIG1/2CS10
		1/2", DN15	12 mm	FIG1/2CS12
		1/2", DN15	14 mm	FIG1/2CS14
		1/2", DN15	15 mm	FIG1/2CS15
		1/2", DN15	16 mm	FIG1/2CS16
		3/4", DN20	18 mm	FIG3/4CS18
	3/4", DN20	22 mm	FIG3/4CS22	
	FIG1/2CSS	Compression fitting for COPPER and STEEL pipe		
		Consisting of compression nut and compression ring and support insert. For valves with internal thread.		
		Note: Support inserts have to be used for copper or soft steel pipe with 1.0 mm wall thickness.		
		3/8", DN10	12 mm	FIG3/8CSS12
		1/2", DN15	12 mm	FIG1/2CSS12
		1/2", DN15	14 mm	FIG1/2CSS14
		1/2", DN15	15 mm	FIG1/2CSS15
		1/2", DN15	16 mm	FIG1/2CSS16
	1/2", DN15	18 mm	FIG1/2CSS18	
	3/4", DN20	18 mm	FIG3/4CSS18	
	FIG1/2M	Compression fitting for MULTILAYER pipe		
		Consisting of compression nut, compression ring and support insert. For valves with internal thread.		
	1/2", DN15	16 mm	FIG1/2M16X2	
	FEG3/4CS	Compressions fitting for copper and precision steel pipes		
		One-piece fitting with steel reinforced elastic ring. For valves with external thread.		
		3/4" Euroconus	10 mm	FEG3/4CS10
		3/4" Euroconus	12 mm	FEG3/4CS12
		3/4" Euroconus	14 mm	FEG3/4CS14
		3/4" Euroconus	15 mm	FEG3/4CS15
		3/4" Euroconus	16 mm	FEG3/4CS16
	3/4" Euroconus	18 mm	FEG3/4CS18	

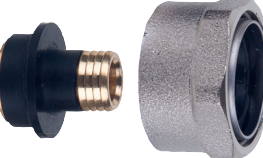
	FEG3/4P	Compression fitting for PEX/PER pipe	
		Consisting of 2 union nuts, 2 compression rings and 2 support inserts. For valves with external thread.	
	$\frac{3}{4}$ " Euroconus	12 x 1.1 mm	FEG3/4P12X1.1
	$\frac{3}{4}$ " Euroconus	16 x 1.5 mm	FEG3/4P16X1.5
	FEG3/4PM	Compression fitting for PEX and MULTILAYER pipe	
		Consisting of a nut with pre-assembled anti-torsion compression ring and a reinforcing insert. For valves with external thread.	
	$\frac{3}{4}$ " Euroconus	14x2 mm	FEG3/4PM14X2
	$\frac{3}{4}$ " Euroconus	16x2 mm	FEG3/4PM16X2
	$\frac{3}{4}$ " Euroconus	16x2.2 mm	FEG3/4PM16X2.2
	$\frac{3}{4}$ " Euroconus	17x2 mm	FEG3/4PM17X2
	$\frac{3}{4}$ " Euroconus	18x2 mm	FEG3/4PM18X2
$\frac{3}{4}$ " Euroconus	20x2 mm	FEG3/4PM20X2	

SPARE PARTS

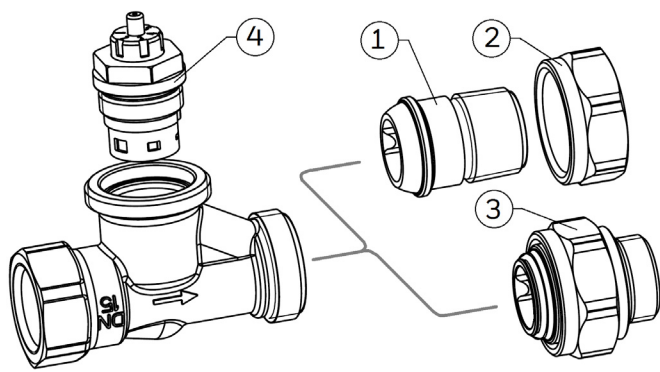
Overview	Description	Dimension	Part No.
	1 Metal-to-metal sealing radiator tailpiece		
		$\frac{3}{8}$ ", DN10	VA5200B010
		$\frac{1}{2}$ ", DN15	VA5200B015
		$\frac{3}{4}$ ", DN20	VA5200B020
	2 Coupling nut, nickel plated		
		DN10, nut with G $\frac{5}{8}$ " internal thread	VA5000B010
		DN15, nut with G $\frac{3}{4}$ " internal thread	VA5000B015
		DN20, nut with G 1" internal thread	VA5000B020
	3 Soft sealing radiator tailpiece with nut		
		$\frac{3}{8}$ ", DN10, nut with G $\frac{5}{8}$ " internal thread	VA5536A010
		$\frac{1}{2}$ ", DN15, nut with G $\frac{3}{4}$ " internal thread	VA5536A015
	4 Replacement valve insert		
		SX type	VS1200SX01

For more information

homecomfort.resideo.com/europe



Ademco 1 GmbH
Hardhofweg 40
74821 MOSBACH
GERMANY

Phone: +49 6261 810
Fax: +49 6261 81309

Manufactured for and on behalf of the
Pittway Sàrl, La Pièce 4, 1180 Rolle, Switzerland
by its Authorised Representative Ademco 1 GmbH
EN0H-2112GE23 R0621

Subject to change

© 2021 Pittway Sàrl. All rights reserved.

This document contains proprietary information of
Pittway Sàrl and its affiliated companies and is
protected by copyright and other international laws.
Reproduction or improper use without specific
written authorisation of Pittway Sàrl is strictly
forbidden. The Honeywell Home trademark is used
under license from Honeywell International Inc.

Honeywell Home